

FEIDER

MACHINES



ROTARY HAMMER

FMP800-CL

INSTRUCTION MANUAL

CAUTION: READ THE INSTRUCTIONS BEFORE USE THE TOOL!

CONTENTS

1. INTENDED USE	3
2. SAFETY INSTRUCTIONS	3
3. PRODUCT DESCRIPTION	5
4. TECHNICAL DATA	6
5. ASSEMBLY	7
6. OPERATION	8
7. MAINTENANCE AND CLEANING	10
8. DISPOSAL	10
9. DECLARATION OF CONFORMITY	10
10. WARRANTY	11
11. PRODUCT FAILURE	12
12. WARRANTY EXCLUSIONS	13

1. INTENDED USE

The machine is intended for hammer drilling in concrete, brick and stone, as well as for light chiseling work, it is also suitable for drilling without impact in wood, metal, ceramic and plastic.

2. SAFETY INSTRUCTIONS

2.1 GENERAL POWER TOOL SAFETY WARNINGS

 **WARNING** Read all safety warnings and all instructions. *Failure to follow the warnings and instructions may result in electric shock, fire and/or serious injury.*

Save all warnings and instructions for future reference. *The term "power tool" in the warnings refers to your mains-operated (corded) power tool or battery-operated (cordless) power tool.*

1) Work area safety

a) **Keep work area clean and well lit.** *Cluttered or dark areas invite accidents.*

b) **Do not operate power tools in explosive atmospheres, such as in the presence of flammable liquids, gases or dust.** *Power tools create sparks which may ignite the dust or fumes.*

c) **Keep children and bystanders away while operating a power tool.** *Distractions can cause you to lose control.*

2) Electrical safety

a) **Power tool plugs must match the outlet. Never modify the plug in any way. Do not use any adapter plugs with earthed (grounded) power tools.** *Unmodified plugs and matching outlets will reduce risk of electric shock.*

b) **Avoid body contact with earthed or grounded surfaces, such as pipes, radiators, ranges and refrigerators.** *There is an increased risk of electric shock if your body is earthed or grounded.*

c) **Do not expose power tools to rain or wet conditions.** *Water entering a power tool will increase the risk of electric shock.*

d) **Do not abuse the cord. Never use the cord for carrying, pulling or unplugging the power tool. Keep cord away from heat, oil, sharp edges or moving parts.** *Damaged or entangled cords increase the risk of electric shock.*

e) **When operating a power tool outdoors, use an extension cord suitable for outdoor use.** *Use of a cord suitable for outdoor use reduces the risk of electric shock.*

f) **If operating a power tool in a damp location is unavoidable, use a residual current device (RCD) protected supply.** *Use of an RCD reduces the risk of electric shock.*

NOTE the term "residual current device (RCD)" may be replaced by the term "ground fault circuit interrupter (GFCI)" or "earth leakage circuit breaker (ELCB)".

3) Personal safety

a) **Stay alert, watch what you are doing and use common sense when operating a power tool. Do not use a power tool while you are tired or under the influence of drugs, alcohol or medication.** *A moment of inattention while operating power tools may result in serious personal injury.*

b) **Use personal protective equipment. Always wear eye protection.** *Protective equipment such as dust mask, non-skid safety shoes, hard hat, or hearing protection used for appropriate conditions will reduce personal injuries.*

c) **Prevent unintentional starting. Ensure the switch is in the off-position connecting to power source and/or battery pack, picking up or carrying the tool.** *Carrying power tools with your finger on the switch or energizing power tools that have the switch on invites accidents.*

d) **Remove any adjusting key or wrench before turning the power tool on.** *A wrench or a key left attached to a rotating part of the power tool may result in personal injury.*

e) **Do not overreach. Keep proper footing and balance at all times.** *This enables better control of the power tool in unexpected situations.*

f) **Dress properly. Do not wear loose clothing or jewellery. Keep your hair, clothing and gloves away from moving parts.** *Loose clothes, jewellery or long hair can be caught in moving parts.*

g) **If devices are provided for the connection of dust extraction and collection facilities, ensure these are connected and properly used.** *Use of dust collection can reduce dust-related hazards.*

4) Power tool use and care

a) **Do not force the power tool. Use the correct power tool for your application.** *The correct power tool will do the job better and safer at the rate for which it was designed.*

b) **Do not use the power tool if the switch does not turn it on and off.** *Any power tool that cannot be controlled with the switch is dangerous and must be repaired.*

c) **Disconnect the plug from the power source and/or the battery pack from the power tool before making any adjustments, changing accessories, or storing power tools.** *Such preventive safety measures reduce the risk of starting the power tool accidentally.*

d) **Store idle power tools out of the reach of children and do not allow persons unfamiliar with the power tool or these instructions to operate the power tool.** *Power tools are dangerous in the hands of untrained users.*

e) **Maintain power tools. Check for misalignment or binding of moving parts, breakage of parts and any other condition that may affect the power tool's operation. If damaged, have the power tool repaired before use.** *Many accidents are caused by poorly maintained power tools.*

f) **Keep cutting tools sharp and clean.** *Properly maintained cutting tools with sharp cutting edges are less likely to bind and are easier to control.*

g) **Use the power tool, accessories and tool bits etc. in accordance with these instructions, taking into account the working conditions and the work to be performed.** *Use of the power tool for operations different from those intended could result in a hazardous situation.*



5) Service





a) **Have your power tool serviced by a qualified repair person using only identical replacement parts.** *This will ensure that the safety of the power tool is maintained.*

1.2 HAMMER SAFETY WARNINGS

- **Wear ear protectors.** *Exposure to noise can cause hearing loss.*
- **Use auxiliary handle(s), if supplied with the tool.** *Loss of control can cause personal injury.*
- **Hold power tool by insulated gripping surfaces, when performing an operation where the cutting accessory may contact hidden wiring or its own cord.** *Cutting accessory contacting a "live" wire may make exposed metal parts of the power tool "live" and could give the operator an electric shock.*
- **Wear safety helmet, safety glasses and/or face shield.** *It is also highly recommended that you wear a dust mask and gloves.*

1.3 SYMBOL EXPLANATION

	Conforms to relevant safety standards
	Class II, double isolation (only for charger).
	Do not dispose of old appliances with domestic rubbish.

	Wear eyes protection
	Wear hearing protection
	Wear dust mask
	Read instructions of use

3. PRODUCT DESCRIPTION

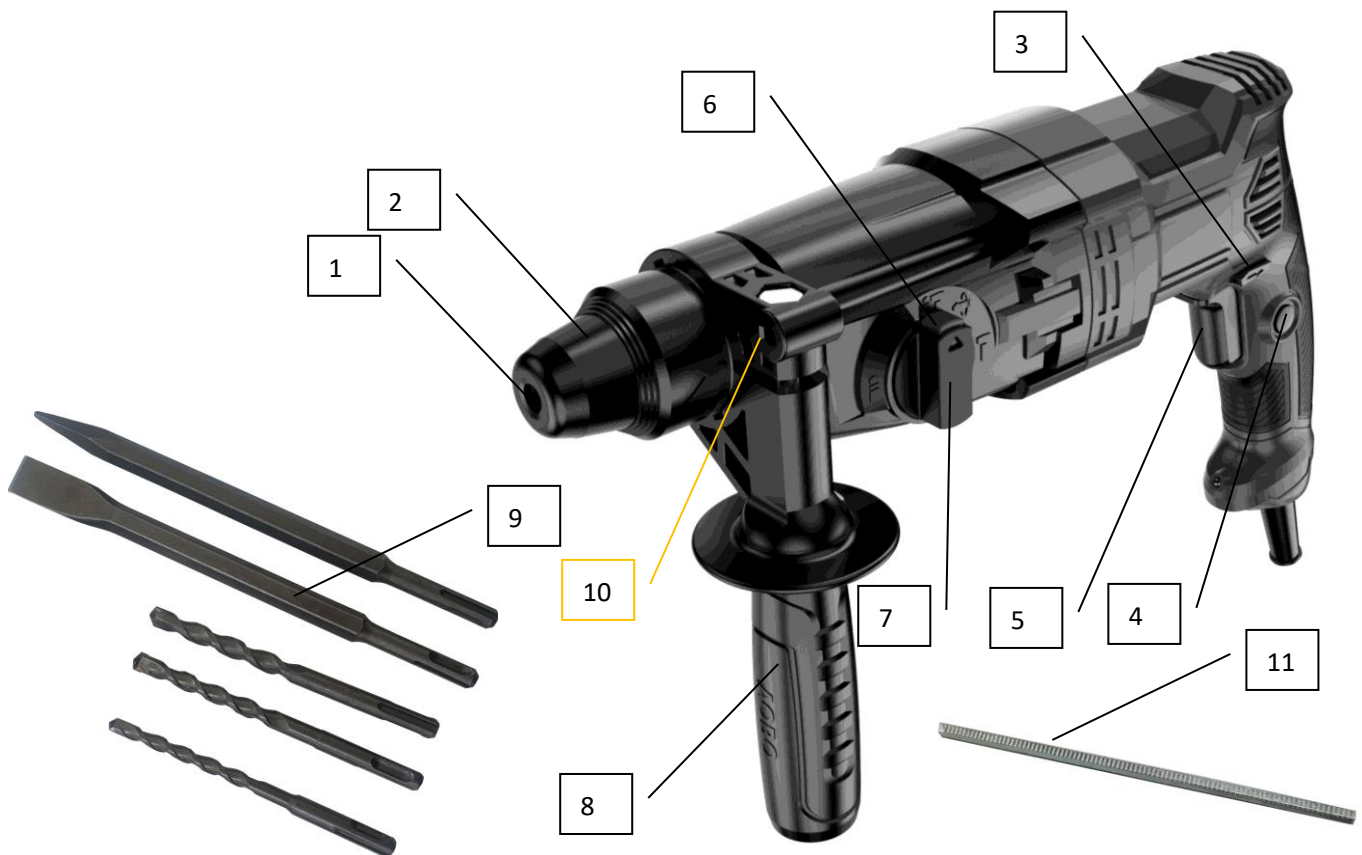

- 1. SDS-plus tool holder
- 2. Locking sleeve
- 3. Rotational direction switch
- 4. Lock-on button for ON/OFF switch
- 5. ON/OFF switch
- 6. Release button for mode selector switch
- 7. Mode selector switch
- 8. Auxiliary handle
- 9. Accessories (8/10/12*150mm drill bits 14*250point chisel 1 pc 14*250 flat chisel 1 pc)
- 10. Guide hole for depth ruler
- 11. Depth ruler

4. TECHNICAL DATA

Model	FMP800-CL	
Rated voltage	220-230V~ 50Hz	
Rated power input	800W	
No load speed	0-1200/min	
Drilling capacity	26mm in concrete	
Impact rate	0-5300BPM	
Impact force	2.2J	
Protection class		
Declaration of the noise emission values		
A-weighted sound pressure level - L_{pA}	94 dB(A)	
A-weighted sound power level - L_{WA}	105 dB(A)	
Uncertainty - $K_{pA} - L_{WA}$	$K = 3$ dB(A)	
Declaration of the vibration emission values	Hammer drill mode	$a_{h,HD} : 14,90 \text{ m/s}^2$
	Chiseling mode	$A_{h,Cheq} : 17,13 \text{ m/s}^2$
Uncertainty K ($a_{h,HD}$, $A_{h,Cheq}$)		$K = 1,5 \text{ m/s}^2$

Information :

- The declared vibration total value has been measured in accordance with a standard test method and may be used for comparing one tool with another.
- The declared vibration total value may also be used in a preliminary assessment of exposure.

Warning:

- that the vibration emission during actual use of the power tool can differ from the declared total value depending on the ways in which the tool is used; and
- Need to identify safety measures to protect the operator that are based on an estimation of exposure in the actual conditions of use (taking account of all parts of the operating cycle such as the times when the tool is switched off and when it is running idle in addition to the trigger time).
- Wear hearing protection.

5. ASSEMBLY

Before any work on the power tool itself, pull the mains plug.

Auxiliary handle

Operate your power tool only with the auxiliary handle.

Rotating the auxiliary handle

The auxiliary handle can be adjusted to any position in order to have a safe and fatigue-free working position.

Loosen the lower part of the auxiliary handle and rotate the handle to the desired position. Then retighten the lower part of the auxiliary handle.

Inserting SDS-plus drilling tools

The SDS-plus drill chuck allows easy and convenient changing of drilling tools without using additional tools. Clean and lightly grease the shank end of the tool.

Insert the tool by turning it into the tool holder until it locks.

Check the lock by pulling the tool.

As a system requirement, the SDS-plus drill bit can move freely. This causes some radial runout when empty, which does not affect hole accuracy because the bit self-centers while drilling.

Removing SDS-plus drilling tools

Push back the locking sleeve and remove the tool.

Adjusting the drilling depth

The required drilling depth can be set with the depth stop.

Insert the SDS-PLUS drill tool up to the stop in the SDS-plus tool holder. Otherwise, moving the SDS-plus drilling tool can lead to incorrect setting of the drilling depth.

Loosen the lower part of the auxiliary handle and insert the depth stop into the auxiliary handle. Pull the depth stop until the distance between the tip of the drill bit and the tip of the depth stop corresponds to the desired drilling depth. Then tighten the handle.

Selecting drill chucks and Tools

For hammer drilling and chiseling, SDS-plus tools are required that inserted in the SDS-plus drill chuck.

Note: Do not use tools without SDS-plus for hammer drilling or chiseling! Tools without SDS-plus and their drill chucks are damaged by hammer drilling or chiseling.

Dust protection cap

The dust protection cap largely prevents the entry of drilling dust into the tool holder during operation. When inserting the tool. Take care that the dust protection cap is not damaged.

A damaged dust protection cap should be changed immediately. We recommend having this carried out by an after-sales service.

6. OPERATION

Switch on and off

Make sure the rotation switch is in its center position.

Connect the tool to the power supply.

Press the left or right rotation switch.

To start the machine, press the ON/Off switch.

To lock the ON/Off switch, it is best to turn it off and press the lock button again.

To switch off the machine, release the ON/Off button.

When the ON/OFF switch is locked, press it and then release it.

Place the switch in its center position to secure the ON/OFF switch.

Setting the Operating Mode

The operating mode of the power tool is selected with the mode selector switch.

Note: Change the operating mode only when the machine is switched off! Otherwise, the machine can be damaged.

To change the operating mode, push the release button and turn the mode selector switch to the requested position until it can be heard to latch.

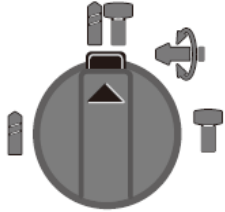

Position for **hammer drilling** in concrete or stone

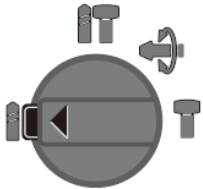

Position for **drilling** without impact in wood, metal, ceramic and plastic as well as for screwdriving and thread cutting



Vario-Lock position for adjustment of the chiseling position
The mode selector switch does not latch in this position.

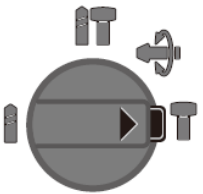

Position for **chiseling**

Sense of rotation

The direction of rotation switch is used to change the direction of rotation of the machine. Switch off and unlock the ON/OFF switch before changing the direction of rotation.

Clockwise rotation: press the right rotation switch (forward arrow)

Counter-clockwise rotation: press the left rotation switch (backward arrow)

Setting the Speed/Impact Rate

The speed/impact rate of the switched-on power tool can be variably adjusted, depending on how far the ON/OFF switch is pressed.

Light pressure on the ON/OFF switch results in low speed/impact rate. Further pressure on the switch increases the speed/impact rate.

Overload Clutch

If the tool insert becomes caught or jammed, the drive to the drill spindle is interrupted. Because of the forces that occur always hold the power tool firmly with both hands and provide for a secure stance.

If the power tool jams, switch the machine off and loosen the tool insert. When switching the power tool on with the drilling tool jammed, high reaction torques can occur.

Working Instructions

The chisel can be locked in 36 positions. In this manner, the optimum working position can be set for each application.

Insert the chisel into the tool holder.

Turn the mode selector switch to the "Vario-lock" position (See "setting the operating mode"). Turn the tool holder to the desired chiseling position.

Turn the mode selector switch to the chiseling position, the tool holder is now locked.

For chiseling, set the rotation direction to right rotation.

Inserting screwdriver bits

Apply the power tools to the screw/nut only when it is switched off. Rotating tool inserts can slip off.

To work with screwdriver bits, a universal bit holder with SDS-plus shank (accessory) is required.

Clean the shank end of the adapter shank and apply a light coat of grease.

Insert the universal bit holder with a turning motion into the tool holder until it automatically locks.

Check the locking effect by pulling the universal bit holder.

Insert a screwdriver bit into the universal bit holder. Use only screwdriver bits that match the screw head.

To remove the universal bit holder, pull the locking sleeve 6 toward the rear and remove the universal bit holder 15 out of the tool holder.

7. MAINTENANCE AND CLEANING

Before any work on the power tool itself, pull the mains plug.

For safe and proper working, always keep the power tools and the ventilation slots clean.

A damaged dust protection cap should be changed immediately. We recommend having this carried out by after-sales service.

If the supply cord is damaged, it must be replaced by a special cord or assembly available from the manufacturer or its service agent.

Others maintenance and inspection shall be provided by a service agent.

8. DISPOSAL



Electrical products should not be discarded with household products. According to the European Directive 2012/19/UE on waste electrical and electronic equipment and its implementation into national law, electrical products used must be collected separately and disposed of at collection points provided for this purpose. Talk with your local authorities or dealer for advice on recycling.

9. DECLARATION OF CONFORMITY



BUILDER SAS

32, rue Aristide Bergès –Z1 31270 Cugnaux - France
Tel : +33 (0)5.34.508.508 Fax : +33 (0)5.34.508.509

ROTARY HAMMER

ZI, 32, rue Aristide Bergès – 31270 Cugnaux – France

Declare that the following tool:

HAMMER DRILL

FMP800-CL

Serial number: 20221014489-20221015088

Is in conformity with the Directive « machine » 2006/42/CE

Also in conformity with the following Directives:

Directive EMC 2014/30/EU

Directive ROHS 2011/65/EU

Also in conformity with the following standards

EN 60745-1:2009+A11:2010

EN 60745-2-6:2010

EN 55014-1:2017+A11: 2020

EN 55014-2:2015

EN IEC 61000-3-2: 2019

EN61000-3-3 :2013+A1: 2019

Responsible of the technical file: M. Olivier Patriarca

Cugnaux, 07/09/2020

Philippe MARIE / PDG

A handwritten signature in black ink, appearing to read 'Philippe Marie', is written over a circular stamp or seal.

10. WARRANTY

The manufacturer guarantees the product against defects in material and workmanship for a period of 2 years from the date of the original purchase. It can be extended by one year if the user subscribes to website of my swap. The warranty only applies if the product is for household use. The warranty does not cover breakdowns due to normal wear and tear.

The manufacturer agrees to replace parts identified as defective by the designated distributor. The manufacturer does not accept responsibility for the replacement of the machine, in whole or in part, and/or ensuing damage.

The warranty does not cover breakdowns due to:

- insufficient maintenance.
- abnormal assembly, adjustment or operations of the product.
- parts subject to normal wear and tear.

The warranty does not extend to:

- shipping and packaging costs.
- using the tool for a purpose other than that for which it was designed.
- the use and maintenance of the machine done in a manner not described in the user manual.

Due to our policy of continuous product improvement, we reserve the right to alter or change specifications without notice. Consequently, the product may be different from the information contained therein, but a modification will be undertaken without notice if it is recognized as an improvement of the preceding characteristic.

READ THE MANUAL CAREFULLY BEFORE USING THE MACHINE.

When ordering spare parts, please indicate the part number or code, you can find this in the spare parts list in this manual. Keep the purchase receipt; without it, the warranty is invalid. To help you with your product, we invite you to contact us by phone or via our website:

+33 (0)9.70.75.30.30

<https://services.swap-europe.com/contact>

You must create a "ticket" via the web platform.

Register or create your account.

Indicate the reference of the tool.

Choose the subject of your request.

Describe your problem.

Attach these files: invoice or sales receipt, photo of the identification plate (serial number), photo of the part you need (for example: pins on the transformer plug which are broken).



11. PRODUCT FAILURE

WHAT TO DO IF MY MACHINE BREAKS DOWN?

If you bought your product in a store:

- Make sure that your machine is complete with all accessories supplied, and clean! If this is not the case, the repairer will refuse the machine.
- Go to the store with the complete machine and with the receipt or invoice.

If you bought your product on a website:

- Make sure that your machine is complete with all accessories supplied, and clean! If this is not the case, the repairer will refuse the machine.
- Create a SWAP-Europe service ticket on the site: <https://services.swap-europe.com> When making the request on SWAP-Europe, you must attach the invoice and the photo of the nameplate (serial number).

Contact the repair station to make sure it is available before dropping off the machine.

Go to the repair station with the complete machine packed, accompanied by the purchase invoice and the station support sheet downloadable after the service request is completed on the SWAP-Europe site

Please keep your original packaging to allow for after-sales service returns or pack your machine with a similar cardboard box of the same dimensions.

For any question concerning our after-sales service you can make a request on our website <https://services.swap-europe.com>

Our hotline remains available at +33 (9) 70 75 30 30.



12. WARRANTY EXCLUSIONS

THE WARRANTY DOES NOT COVER:

- Start-up and setting up of the product.
- Damage resulting from normal wear and tear of the product.
- Damage resulting from improper use of the product.
- Damage resulting from assembly or start-up not in accordance with the user manual.
- Breakdowns related to carburetion beyond 90 days and fouling of carburetors.
- Periodic and standard maintenance events.
- Actions of modification and dismantling that directly void the warranty.
- Products whose original authentication marking (brand, serial number) has been degraded, altered or withdrawn.
- Replacement of consumables.
- The use of non-original parts.
- Breakage of parts following impacts or projections.
- Accessories breakdowns.
- Defects and their consequences linked to any external cause.
- Loss of components and loss due to insufficient screwing.
- Cutting components and any damage related to the loosening of parts.
- Overload or overheating.
- Poor power supply quality: faulty voltage, voltage error, etc.
- Damages resulting from the deprivation of enjoyment of the product during the time necessary for repairs and more generally the costs related to the immobilization of the product.
- The costs of a second opinion established by a third party following an estimate by a SWAP-Europe repair station
- The use of a product which would show a defect or a breakage which was not the subject of an immediate report and/or repair with the services of SWAP-Europe.
- Deterioration linked to transport and storage*.
- Launchers beyond 90 days.
- Oil, petrol, grease.
- Damages related to the use of non-compliant fuels or lubricants.

* In accordance with transport legislation, damage related to transport must be declared to carriers within 48 hours maximum after observation by registered letter with acknowledgement of receipt.

This document is a supplement to your notice, a non-exhaustive list.

Attention: all orders must be checked in the presence of the delivery person. In case of refusal by the delivery person, it you must simply refuse the delivery and notify your refusal.

Reminder: the reserves do not exclude the notification by registered letter with acknowledgement within 72 hours.

Information:

Thermal devices must be wintered each season (service available on the SWAP-Europe site). Batteries must be charged before being stored.





FEIDER

MACHINES



BUILDER SAS
32, rue Aristide Bergès - ZI 31270 Cugnaux – France
Made in PRC 2022